

Tables hautes descriptif technique





Informations générales :

Garantie :

5 ans.

Composants électriques et tissus - 2 ans.

Mélaminé - certifié :



Densité du panneau :

12 mm - 690 - 750 kg/m³

18 mm - 650 - 690 kg/m³

28 mm - 610 - 630 kg/m³

36 mm - 610 - 630 kg/m³

Montage :

livrée en pièces détachées

Emballage :

carton

Tables hautes

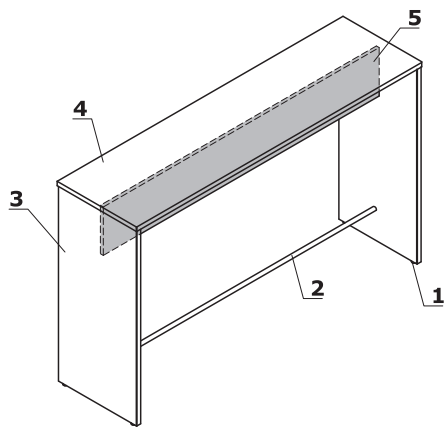

1. Vérins de réglage - course de 5 mm
2. Tube acier - finition peinture poudre époxy, Ø30 mm
3. Pied - mélaminé 28 mm, chants ABS
4. Plateau - mélaminé 28 mm, chants ABS
5. Voile de fond - panneau mélaminé 18 mm

Tables hautes

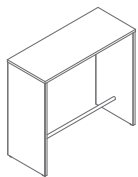

PSW52
1200 / 500 / 1100
34 kg

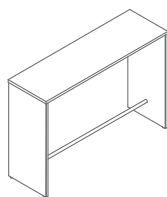

PSW56
1600 / 500 / 1100
39 kg

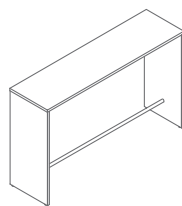

PSW58
1800 / 500 / 1100
41 kg

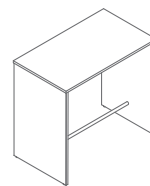

PSW72
1200 / 700 / 1100
46 kg

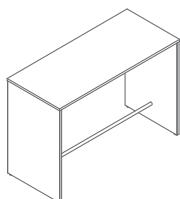

PSW76
1600 / 700 / 1100
52 kg

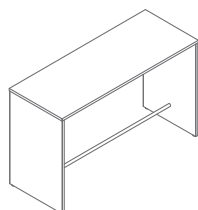

PSW78
1800 / 700 / 1100
55 kg

Plateau, pied



14 Hêtre

26 Aluminium
satiné31 Chêne
canadien

34 Wengé



39 Bouleau clair



64 Cacao



67 Blanc pastel



106 Noyer



154 Anthracite



08 Noir